



*Top A312 / Top A412*  
User guide

## Dear customer

Thank you for purchasing one of our products.

### About the set

In choosing the Top A312/Top A412 you have acquired a cordless telephone for analogue connections that combines the advantages of flexibility with the user comfort of high-quality telephones. The set itself features modern digital technology to the European standard for cordless telephones (DECT). DECT technology features speech encryption that provides a high level of security against unauthorised interception as well as crystal-clear transmission.

In addition to the usual telephone features the Top A312/Top A412 also offers:

- Menu guidance for all functions
- Directory (storage of up to 150 names and numbers)
- Adjustable charge meter
- Last number redial for the last 15 numbers
- Expansion option to a telephone system:
  - operating up to 6 handsets on a base station
  - free internal calls between 2 handsets
  - Operating a handset on up to 4 base stations (option for extending the range)
- Hands-free operation
- Direct call/babyphone feature
- Digital answering machine (Top A412 only)

### Safety notes

Please read all the safety notes before putting the set into operation:

- Safety notes

### Operating the set

To make good use of all the features of your new telephone we recommend that you read the following sections in particular:

- Setting up the telephone and putting it into service
- Basic settings and operation
- Setting the dialling method
- Setting the answering machine (Top A412 only)

### Note:

This user guide describes the maximum extent of functions the Top A312/Top A412 can provide. Due to applicable country regulations or circumstances relating to the network operator or provider, there may be some differences or limits to the functions or operation as described in this user guide.







If you have any questions, please contact the Swisscom Information Service (freephone 0800 800 800).

# Explanations

## Handset



## Display icons

- |  |                                  |   |  |
|--|----------------------------------|---|--|
|  | Answering machine is on          |  | Battery indicator                        |
|  | New message on answering machine |  | Display of handset number (internal 1-6) |
|  | Base station indicator           |  | Ringer off                               |

# Explanations

## Base station without answering machine



- Internal key/  
paging key
- flashes slowly to indicate incoming calls, internal and external connections and group calls (paging)
  - flashes rapidly to indicate handset log-on

## Base station with answering machine ( Top A412 only)



- Answering machine  
On/Off key
- Internal key/paging key
- Light red:
- continual fast flash to indicate incoming message (answering machine)
  - continual double-flash to indicate full answering machine memory or PIN alarm (remote operation)
  - lit if answering machine is on
  - flashes slowly to indicate incoming calls, internal and external connections and group calls (paging)
  - flashes rapidly to indicate handset log-on

# Quick Reference User Guide

This guide covers the main operating sequences. For further information please refer to the detailed User Guide.

After pressing the menu key below "" you have the following choice:

## Main menu in standby state

Answer. machine (Top A412 only)

Key lock

Ringer On/Off

Handset settings

BaseStat. settings

Service function

Charges

Prov. services

## Menu in the communication state

Volume (hands-free operation only)

Loudspeaker (Top A412 only)

Provider services

Handset volume

Send DTMF/keypad

Directory

Recording on/off (Top A412 only)

Listening 2nd handset

## Logging the handset on

1. On the base station keep  pressed until the LED flashes.
2. In the menu of the handset under "BaseStat. setting" – "Log on" – "On base station" prepare the handset for log on.

## Logging the handset onto another base station

1. Prepare the other base station.
2. In the menu of the handset under "BaseStat. setting" – "Log on" – "On other system" prepare the handset for log on.



## Last number redial

1. Press .
2. ,  Select entry.
3. Press .

## Dialling from the directory

1. Press .
2. Enter initial letters.
3. ,  Select entry.
4. Press .

## Directory entry

1. Enter the number.
2. Press .
3. Enter name.
4. Press .
5. Enter any required options.

## Babyphone



You can use your handset as a babysitter (monitoring handset) and monitor a room e.g. a child's bedroom for noises. To do this you need two handsets, both logged on to the base station.

As soon as the preset noise level is exceeded, the monitoring handset automatically makes an internal call to the destination handset. You can select one of three noise levels.





# Quick Reference User Guide

## Speed dialling

The numerical keys can be used to program a speed-dial number for a directory entry. Only one key can be programmed per directory entry.





1. Press .
2. Select "Handset settings".
3. Press **OK**.
4. Select "Speed dialling".
5. Press **OK**.
6. Press **i**.
7. Select the .
8. Press **OK**.

## Making an internal call between two handsets

1. Press .
2. Press  ... .
3. Make your call.
4.  End your call.

## Transferring a call internally



You are in the middle of an external call.

1. Press .
2. Enter  ...  internal number.
3. Press **OK**.
4.  End your call.

*The external call partner is now connected to the second internal call partner.*

## Transferring a call externally

You are in the middle of an internal call.

1. Press .
2. Enter zero (for external) plus the external number.
3. Press **OK**.
4.  End your call.

*The internal call partner is now connected to the external call partner.*

## Switching hands-free operation on

You are in the middle of a call.

1. Press the multifunction key on the handset.
2. Put the handset down.
3. Continue the call in hands-free mode.

## Switching hands-free operation off

Hands-free operation is on.

1. Press the multifunction key on the handset.
2. Hold the handset to your ear.
3. Continue the call.

# Quick Reference User Guide

## Switching the answering machine

### On/Off at the base station

Press  until the signal tone is heard.

*The answering machine is switched on.*

The answering machine is on.

Press  until the signal tone is heard.

*The answering machine is now off.*



### Top A412

#### Quick Reference Guide for remote operation of the answering machine

##### Remote initiating procedure:

1. Dial your number.
2. While the outgoing message is playing, key in your personal remote access PIN.

**or** (the answering machine is off)

1. Dial your number and wait for approx. 10–12 rings.
2. Answering machine switches itself on for 8 seconds without playing an outgoing message.
3. When the ready beep sounds, enter your remote access PIN.

- |  |  |   |
|--|--|---|
|  = Rewind<br>Select outgoing msg. A         |  = Record   |  = Delete messages                         |
|  = Stop                                     |  = Delete all messages                                  |  = Cancel procedure<br>(from handset only) |
|  = Forward (message B)<br>Play back message |  = Show recording time remaining<br>(from handset only) |   |
|  = On/Off                                   |  = Select time-over message                             |   |

---

**From the handset and by remote access**

---

**Messages**

- Play back **3**
- Jump forward **3**
- Jump back **1**
- Stop **2**
- Delete individual messages (during playback) **0**

---

**Delete** (the answering machine is off)

- All messages from remote **0 7 0**
- Outgoing message A **0 1**
- Outgoing message B **0 3**
- Time-over message **0 9**

---

**Recording**

- Outgoing message A **5 1**
  - Outgoing message B **5 3**
  - Time-over message **5 9**
- 
- Switch answering machine on/off **4**



# Table of contents

<b>Quick Reference User Guide</b> .....	1	Dialling from the directory	20
<b>Safety notes</b> .....	8	Deleting a directory entry	20
<b>Contents of the package</b> .....	8	Using a directory entry for off-line call preparation	20
Accessories .....	8	<b>During a call</b> .....	<b>21</b>
<b>Setting up the telephone and putting it into service</b> .....	<b>9</b>	Hands-free mode	21
Suitable location .....	9	Menu in communication state	21
Range .....	9	Adjusting the handset volume	22
Protection against listening-in	9	Send keypad/DTMF	22
Connecting the base station	10	Directory	22
Disconnecting the cables from the base station	10	Mute switch	22
Inserting the batteries in the handset	11	Recording a telephone call (Top A412 only)	22
Charging the batteries	12	Listening with a second handset	23
Battery endurance between charging	12	Provider services	23
Battery indicator	12	<b>Internal calls</b> .....	<b>24</b>
Disposal	12	Making calls between two handsets	24
<b>Basic settings and operation</b> .....	<b>13</b>	Paging from the handset	24
Finding your way around in the user guide	15	Paging from the base station	24
Calling up a menu function (navigation) 15		<b>Local switching functions</b> .....	<b>25</b>
Selecting a setting	16	Internal call waiting	25
Switch functions on/off	16	Inquiry	25
Important basic settings	16	Alternating between calls (brokering)	25
<b>External calls</b> .....	<b>17</b>	Three-party conference	26
Dialling out with the numeric keypad	17	Return to brokering/end three-party conference	26
Accepting a call	17	End brokering	26
Speed dialling	17	Call handover/connect	26
Ending a call	17	<b>Shortcuts to functions</b> .....	<b>27</b>
Off-line call preparation	17	Programming	27
Dialling from the redial register	18	Taking a shortcut	27
Further dialling options	18	<b>Provider services</b> .....	<b>28</b>
Editing the redial register	18	Call forwarding	28
<b>Directory</b> .....	<b>19</b>	Activating call forwarding	28
Storing an entry in the directory	19	Deactivating call forwarding	29
Setting/changing options	19	Showing call forwarding	29
Editing a directory entry	20	Adapting (programming) provider services	29
		Using more services	31

# Table of contents

Brief description of services (during a connection) .....	31
Brief description of services (without a connection) .....	32
Combox .....	33
Blue key .....	33
<b>Advice of charge and call duration 34</b>	
Setting the factor .....	34
Setting the currency .....	34
Displaying/deleting totals .....	35
Display type .....	35
<b>Using several handsets ..... 36</b>	
Preparing the base station for log on .....	36
Logging a handset on .....	36
Logging a handset onto another base station (GAP) .....	37
Logging another handset onto the base station (GAP) .....	37
GAP uses .....	38
Logging a handset off from a base station .....	38
Application example .....	39
Selecting a base station .....	39
<b>Direct call (babyphone feature) ..... 40</b>	
Activating direct call .....	40
Initiating a direct call .....	40
Deactivating direct call .....	40
<b>Keypad lock/ringer off ..... 41</b>	
Keypad lock on .....	41
Keypad lock off .....	41
Ringer off .....	41
Ringer on .....	41
<b>Handset settings ..... 42</b>	
Setting the language .....	42
Switching the handset on/off .....	42
Selecting the battery type .....	42
Keyclick .....	43
Range beep .....	43
General settings .....	43
Charging beep .....	43
Direct accept .....	43
Backlight .....	43
Handset ringer .....	44
Increasing .....	44
Handset PIN .....	45
<b>Base station settings ..... 46</b>	
Base station ringer .....	46
Time and date .....	46
Base station PIN .....	47
Call allocation .....	47
Public access code .....	48
PBX .....	48
Setting the dial pause .....	48
<b>Service function ..... 49</b>	
Programming the babyphone .....	49
Babyphone .....	49
Switching babyphone on .....	49
Switching babyphone off .....	50
Transferring directory entries to other handsets .....	51
Before the transfer .....	51
Transmitting entries .....	51
Receiving entries .....	51
Selecting providers .....	52
Resetting the handset to the default setting .....	53
Resetting the directory .....	53
Resetting the base station to the default setting .....	53
Software version .....	53
<b>Setting the answering machine .... 54</b>	
Introduction .....	54
Functions .....	54
Characteristics .....	54
Date and time .....	54
Setting the number of rings .....	55
Activating/deactivating message monitoring .....	55
Time limit .....	55

# Table of contents

Operating modes ..... 56  
Selecting an operating mode ..... 56  
Setting the language of the standard message (plug & play) ..... 56  
Time-over message ..... 57

## **Operating the answering machine from the handset ..... 58**

Introduction ..... 58  
Switching the answering machine on/off ..... 58  
Recording an outgoing message ..... 58  
Changing the operating mode/monitoring the outgoing message .... 59  
Deleting an outgoing message ..... 59  
Displaying new messages ..... 59  
Playing back recorded messages ..... 60  
During playback ..... 60  
Deleting messages ..... 60  
Active answering machine ("Pick up") ..... 61  
Temporary call screening ..... 61  
Recording telephone calls ..... 61  
Checking the time left for recording . 61

## **Operating the answering machine from the base station ..... 62**

Answering machine on/off ..... 62

## **Operating the answering machine by remote access ..... 63**

Introduction ..... 63  
Remote access PIN ..... 63  
Access via remote access ..... 64  
PIN alarm ..... 64  
Switching the answering machine on/off ..... 64  
Playing back recorded messages ..... 65  
During playback ..... 65  
Functions with the answering machine switched on ..... 65  
Functions with the answering machine off ..... 66

## **General information ..... 67**

Troubleshooting ..... 67  
Repair and Maintenance ..... 68  
Batteries ..... 68  
Help ..... 68  
Cleaning – when it is necessary ..... 68  
Approval ..... 68

## **Technical Data ..... 69**

CE mark ..... 69

## **Menu structure in standby state .... 70**

## **Key words ..... 74**

## **Declaration of Conformity ..... 77**

# Safety notes/Contents of the package

The DECT cordless telephone is used for transmitting voice via the analogue telephone network.

The User Guide and its safety notes are an integral part of the equipment and must be handed over to the new owner when reselling the equipment.

## Safety notes

### Warning!

Use only nickel metal hydride (Ni-MH AAA) batteries, preferably with more than 650 mAh.

Using other types of rechargeable batteries or ordinary batteries (i.e. non-rechargeable) can be dangerous and also lead to malfunctions of and/or damage to the set. The manufacturer accepts no liability in such cases.

- Make sure the correct battery type is set and the batteries are fitted correctly.
- Do not dip the batteries in water; do not throw them into the fire.
- Batteries can become warm when being charged; this is a normal and harmless process.
- To avoid damage to the batteries, do not use charging stations from other manufacturers.
- For the base station and the charging bay use only the power supply unit supplied.

- Before using the telephone, **hearing-aid users** should note that radio signals interfere with hearing aids and cause an unpleasant humming noise if sufficiently loud.

### Warning!

Please note that the ringtone for incoming calls as well as alert tones, handsfree and listening by loudspeaker tones are also emitted on the handset. Do not therefore hold the handset close to your ear while one of these functions is on, otherwise your hearing may be affected.

## Contents of the package

The package contains the following items:

- Handset
- 3 NiMH (AAA) battery cells
- Base station
- Mains adapter
- Connection cord
- User manual incl. Quick Reference Guide

## Accessories

The following accessories are available from Swisscom outlets:

- Additional handsets with base station
- Additional base stations

# Setting up the telephone and putting it into service

## Suitable location

Your telephone is designed for normal use in domestic and office buildings. Keep the following points in mind when selecting a location for it:

### Suitable

- In the centre of your radius of action
- At least 1 m distance between the base station resp. handset or telephone and other electronic devices

### Unsuitable

- On a metallic surface or an underlay prone to slipping
- Near electronic devices (e.g. HiFi equipment, TV, microwaves)
- Near sources of radiation (e.g. radiators, direct sunlight)
- Behind steel doors, or glass doors with metal mesh
- In niches or shielded rooms
- Without an underlay on painted or lacquered furniture or on plastics

## Range

The operating range is as follows:

- Outdoors approx. 250 m
- Indoors approx. 40 m, depending on ambient conditions and building-related factors

### Outside the operating range:

- Range warning beep sounds (if switched on)
- Disconnection of the call

### Note:

Silent zones within the operating range, depending on the structural environment, may cause brief interruptions to a call or loss of the connection.

## Protection against listening-in

Between the base station and the handset, calls are transmitted in encrypted form to prevent the possibility of listening in with other cordless telephones, radio receivers or scanners.

# Setting up the telephone and putting it into service

## Connecting the base station

### Warning:

Make sure you do not confuse the plugs of the telephone line cable and the plug-in power supply cord on the base station.

- If you do connect the plugs the wrong way round, the base station will not function and may be damaged.

### Telephone line cable

The telephone line cable has two different plugs:

1. Insert the smaller plug into the socket (telephone icon) underneath your telephone until the plug snaps firmly into place.
2. Feed the cord through the moulded cable duct provided.
3. Connect the larger plug to your telephone socket.

### Power supply cable

1. Insert the plug of the power supply cable into the socket marked with the power supply icon until the plug clicks into place.
2. Feed the cable through the cable duct provided.
3. Connect the plug-in power supply to a 230V outlet.

### Note:

Your telephone will not function if the power supply is not plugged in or if the power fails. The telephone may only be used in conjunction with a power supply SNG 6 af, tested in compliance with EN60950 Protection Class 2.

## Base station

Telephone line (cable)      Power supply cable (electricity)



## Disconnecting the cables from the base station

1. First unplug the power supply from the 230V mains socket.
2. To release the plugs, press the snap-in clip towards the plug body (e.g. using a small screwdriver) and at the same time pull the plug out by the cable.

### Note:

#### New cable layout

The new cable layout complies with the European standard. Please note that previous Swisscom telephones have a different cable layout.

Please use the enclosed cable for this telephone.

The following cables are suitable for new installations with RJ 45 connection sockets:  
Length 3m: Art. No. 522.733.5.

You can exchange the enclosed cable for an RJ 454 cable in the Swisscom Shop.

# Setting up the telephone and putting it into service

## Inserting the batteries in the handset

1. Remove the battery compartment cover by pressing it lightly and sliding it downwards.
2. Insert the 3 batteries in the battery compartment (as shown). Make sure the polarity is correct.
3. Slide the battery compartment cover back until it clicks into place.



### Note:

If the batteries are inserted incorrectly, the handset will not function; damage might result.

Only use the same type or brand of batteries in the compartment at any given time.

# Setting up the telephone and putting it into service

## Charging the batteries

The batteries are in a discharged state when supplied; they will first need to be charged:

1. Place the handset in the base station or the charging bay.

*An acknowledgement sound indicates that the handset is correctly positioned.*

### Note:

Do not use ordinary batteries.

Do not place the handset in the charging bay if the batteries have not been fitted.

Before initial use, batteries have to be charged without interruption for at least 12 hours in the case of NiMH batteries.

Only remove the batteries from the handset to replace them with new ones.

Do not charge the batteries out of the handset.

## Battery endurance between charging

A set of NiMH batteries provides approx.:

- 150 hrs standby
- 15 hrs talk time









### Note:

Make sure you select the correct battery type. See section "Handset settings". Charging contacts must not come into contact with metallic or greasy parts.

After long periods out of operation with the power switched off (e.g. during holidays) the batteries will need recharging before the set can be operated again.

## Battery indicator

When the batteries are first inserted, the battery status is unclear. A correct indication in the display is obtained only after a complete charging cycle.

-  flowing: battery charging
-  continuous: battery between 70% and 100%
-  continuous: battery between 50% and 70%
-  continuous: battery between 30% and 50%
-  continuous: battery between 5% and 30%
-  continuous: battery below 5%
-  flashing: battery almost discharged
-  continuous: battery status unclear
-  flashing: battery status unclear and almost discharged

### Note:

If the charge state of the batteries approaches 5%, a warning beep sounds.

## Disposal

Please dispose of rechargeable batteries in an environmentally friendly manner (no household waste).



# Basic settings and operation

## Controls

(Keys + display see fold-out page A2)

## Switching the handset on to standby state

Press the connect key to switch the handset on.

## Display

In the standby state the following are shown:

Internal number of the handset, base station, charge state and date/time.

The following functions are available:

last number redial, directory and main menu.

## Note:

There may be some differences in the text between the user guide and the display.

## Softkey icons (functions of the menu key)

The following icons/texts may be displayed/selected in the bottom display line:

Icon/text	Function
	Select main menu
	Info on an entry in the call register/directory/redial register
	Redial register
	Directory
	Edit directory
	Edit an entry
	Delete an entry
	Change case
	Choose from list
	Switch function on/off
	Delete last character (backspace)
	Call up further menu items (navigate)
	Select settings (ringer melody)
	Reject call waiting during a call
	Microphone → mute on/off
	Alternate between call partners 1 to 2 / 2 to 1 (brokering)
	Confirm selection
	Answer dialogue
	Accept a second call (call waiting) during a call
	Jump forward/back when playing
	Determine options for each directory entry
	Back from directory entry
	Switch available functions on/off

# Basic settings and operation

## Menu key

- Functions are carried out by pressing the fox key directly below the icon in the display

## Cancel key

- Every time you press this key you take one step back in the menu
- Keep the key pressed to get to the standby state

## Internal key

- For making calls to other handsets (internal calls)

## Blue key

- Call Back on Busy (CCBS)

## Control key

- For inquiries to the exchange (for example hold)

## Connect key

- To dial an external number
- To accept or end incoming calls
- To switch the handset on to standby
- In the menu: cancel the procedure and return to the standby state

## Numeric keys

- To enter numbers and letters
- Direct access to functions (shortcuts)

## Numeric key 1

- To show the combox (long press)

## Multifunction key

- To switch hands-free operation on/off

## Keying in names

Below the numbers of the keypad there are letters. To select a letter press the respective key once or several times.

After you have entered an upper case letter the system automatically switches to lower case; after a blank space to upper case.

Keys	When you first press the key	Alphanumeric entry, upper case	Alphanumeric entry, lower case
1	Number 1	., ? ! ; ; - ' " 1	., ? ! ; ; - ' " 1
2	Number 2	A B C 2 Ä Å Á Â Æ Ç	a b c 2 ä å á â æ ç
3	Number 3	D E F 3 È É Ê	d e f 3 è é ê
4	Number 4	G H I 4 Ì Í Î Ï Ñ	g h i 4 ì í î ï ñ
5	Number 5	J K L 5	j k l 5
6	Number 6	M N O 6 Ö Õ Ò Ó Ø Ñ	m n o 6 ö õ ò ó ø ñ
7	Number 7	P Q R S 7 Š Ÿ	p q r s 7 š Ÿ
8	Number 8	T U V 8 Ü Û Ú	t u v 8 ü û ú
9	Number 9	W X Y Z 9	w x y z 9 Ÿ
0	Number 0	+ 0	+ 0
*	Number *	* ( ) = % @ & € \$	* ( ) = % @ & € \$
#	Number #	blank space #	blank space #

# Basic settings and operation



## Finding your way around in the user guide

- Basically, each section or each function is explained with a brief introduction.
- Menu graphics show you where in the menu you need to be in order to call up a function (navigation).
- The instructions therefore only describe the steps within the selected function.
- The steps are consecutively numbered, starting with 1.
- Intermediate results following a step are shown in *italics*.
- Some steps are visualised by a display graphic.
- Always observe the notes on a particular function.



## Calling up a menu function (navigation)

The many functions provided allow you to set up the telephone for your particular requirements. These functions are divided into menus and submenus.

The handset is in standby state

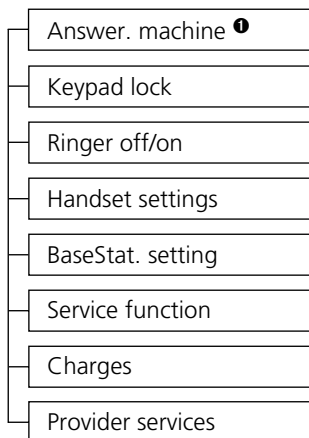
1. Press  .  
*You are now in the main menu where the following functions are available.*



Press "" or "" or "" to navigate vertically in the menu.

**1** Top A412 only

# Basic settings and operation

- If the menu contains submenus (e.g. "Handset settings"), press **OK** to get to the submenu.



- To get to further submenus (e.g. "Language") repeat these steps.

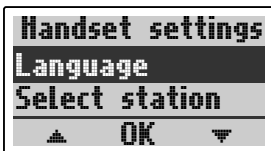

- Press the cancel key to return to the previous menu level.
- By keeping the cancel key pressed down, by pressing the connect key, or if a call arrives, you return to the standby state without any settings having changed.

**Note:**

For an example, see the function "Select language" in the section "Handset settings".

## Selecting a setting

- Click  to select from a list of settings (e.g. "Language").



**Note:**

Only one selection from a list can be made at any given time.

## Switch functions on/off

- Click  /  to switch a function on/off (e.g. keyclick).



**Note:**

Several functions can be on or off at any given time.

## Important basic settings

- Set time/date and dialling type see "Base station settings".

## External calls

Making calls externally means calling via the telephone network (exchange).

### Dialling out with the numeric keypad

Handset is in standby state

1. Press .  
*The dialling tone sounds.*
2. Key in the number.  
*Make your call...*

### Accepting a call



The ringing tone sounds on the base station and the red light 1 flashes slowly. The set melody sounds on the handset. The display shows "Incoming Call". If the number is stored in the directory, the corresponding name appears.

1. Press .  
*Make your call...*

### Speed dialling

Numerical keys can be programmed for speed-dialling directory entries. When the relevant key is held down, the directory entry is speed-dialled.

Only one key can be programmed per directory entry.

1. Press .
2. Select "Handset settings".
3. Press **OK**.
4. Select "Speed dialling".
5. Press **OK**.
6. Press **i**.
7. Select the .
8. Press **OK**.

#### Note:

Deleting the directory entry also deletes the corresponding speed-dial setting.

Once you have programmed speed-dialling you can directly dial the speed-dial number by holding down the relevant key. Speed-dial key 1 is reserved for the Combox number (see "Services").

### Ending a call

During a call:



1. Press .
- or Place the handset on the base station or the charging station.

### Off-line call preparation

Before dialling, a number can be entered via the keypad, or an entry can be taken over or adapted from the directory, the call register or the redial register.

-  Store/edit the number in the directory.



-  Add a directory entry to the number entered.
-  To edit the number.
-  Dial.

#### Note:

If the line has already been in use by another internal handset, the busy tone sounds.

## External calls



### Dialling from the redial register

The last 15 names or numbers dialled are stored automatically and can be redialled using the redial register. If the memory is full, the oldest entry will be overwritten.

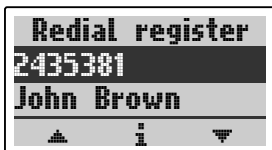
1. Press .



*The last number or name dialled is shown.*

2. ,  Select entry from the redial register.
3. Press .

*The number is dialled.*

### Further dialling options

- Dialling from the directory, see section "Directory".
- Combox dialling, see section "Provider services" "Combox".
- Blue key dialling, see section "Provider services" "Blue key".

### Editing the redial register

You have selected an entry from the redial register:

1. Press .



2. You now have the following options:

 Edit the entry.

 Enter in the directory.

 Delete an entry in the redial register.



Dial.

 Take over the entry for editing in the redial register.

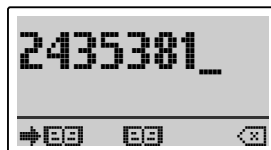

After you have pressed **OK**:

You now have the following options:

 Store the entry in the directory.

 Provide a directory entry for the number entered.

 Edit the number.



Dial.

# Directory

## Storing an entry in the directory

You can compile your personal directory with up to 150 names and numbers:

1. Enter the desired number (max. 24 characters).

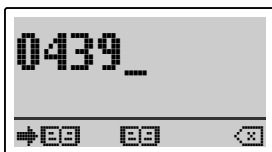

2. Press **←□□**.
3. Enter the desired name (max. 16 characters).
4. Press **OK**.  
*The entry has been saved.*



5. You now have the following options:

**BACK** Back to the idle mode.

**OPT** Set options.

### Note:

New entries can also be entered via **□□** and **NEW**.

## Setting/changing options

For every entry you can set the following options:

**Select provider** The entry is always dialled via this provider

**Others: Identification restriction** Your own number is always suppressed (CLIR).

**External numbers** The exchange identification code is automatically placed in front of the number (function for PABXs).

1. Press **OPT**.
2. Select option.
3. Set option.

### Note:

The "Anonymous calling" supplementary service is not available for all lines. The caller must be connected to an exchange which supports this service. For operation behind a PABX, the exchange identification code need not be entered in the directory. See section "Base station settings – exchange identification code". Program provider – see "Service function – Provider".

# Directory

## Dialling from the directory

1. Press **EE**.
2. **▲, ▼** Find entry in the directory or by keying in up to three initial letters (via the keypad) select the desired name.



3. Press **☎**.  
*The number is now dialled.*

## Editing a directory entry

1. Press **EE**.
2. **▲, ▼** Find entry in the directory.
3. Press **i**.



4. Press **ABC** **<** **☒**.  
*The number is displayed.*

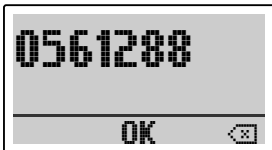

5. Press **☒** to edit the number from right to left.
6. Press **OK**.  
*The name is displayed.*

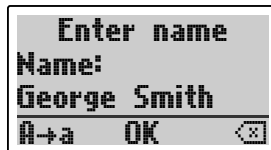

7. Press **☒** to edit the name from right to left.
8. Press **OK**.  
*The entry is saved.*

## Deleting a directory entry

1. Press **EE**.
2. **▲, ▼** Find entry in the directory.
3. Press **i**.
4. Press **☎**.  
"Delete entry?" is displayed.
5. Press YES/NO.  
*YES = deletes directory entry.*

## Using a directory entry for off-line call preparation

1. Press **EE**.
2. **▲, ▼** Find entry in the directory.
3. Press **i**.
4. Press **OK**.  
*The entry is used in off-line call preparation.*
5. You now have the following option:
  - ☎** Save entry in the directory.
  - ☒** Change the entry.
  - EE** Find a further entry in the directory.
  - ☎** Dial.



# During a call

## Menu in communication state

During a call the following functions are available from "☎️":

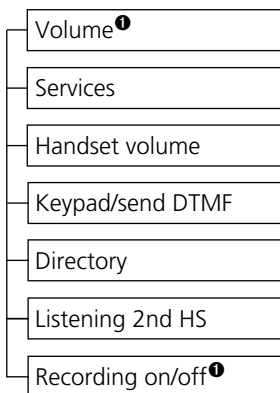

### Note:

If the hands-free mode is on, you should not hold the handset at your ear to provide from any injury caused by the volume. The hands-free mode is also working during the battery is charging.



### Switch hands-free off

1. Hold the handset.
2. Press the multifunction key.

## Hands-free mode

The "hands-free" function allows you to make a call via the handset without having to hold it.

### Switch hands-free on

1. Dial the number.
2. Press .
3. Press the multifunction key.  
*The multifunction key flashes; hands-free mode is now on.*
4. Press ☎️.
5. Select "Volume".
6. Press **OK**.
7. ,  Set volume.
8. Press **OK**.
9. Make your call.

❶ In hands-free mode only

## During a call

### Adjusting the handset volume

To better hear your call partner, you can increase the handset volume during a call:

1. Press **⏸**.
2. Select "Handset volume".
3. **←**, **→** Select your setting.
4. Press **OK**.

Repeat steps 1-4 to reset the handset volume.

#### Note:

Please note that full volume may damage your hearing. The handset volume remains saved.

### Send keypad/DTMF

By switching to temporary DTMF dialling you can use the special keys "star" **\*** and "hash" **#** to transmit information during a call, e.g. for voicemail, answering machine etc.:

1. Press **⏸**.
2. Select "Send DTMF".

#### Note:

After completion of a call, temporary DTMF dialling is automatically switched off.

### Directory

You can access numbers in the directory (see section "Directory").

### Mute switch

If you do not want your call partner to hear you (for instance when you confer with someone in the room) you can switch the handset microphone to mute:

1. Press **⏸**.  
*Your call partner cannot hear you.*
2. Press **⏸**.  
*Your call partner can hear you again.*

### Recording a telephone call (Top A412 only)

When making a call, you have the option of recording the entire call or parts of it. This function can only be activated from the handset to prevent uncontrolled recording from the base station.

#### To start/stop recording

You are in the middle of a call:

1. Press **⏸**.
2. Select "Recording".

#### Note:

Switching on the recording function is signalled to your call partner by a brief acknowledgement beep.

Recording automatically ends if the amount of storage space available is exceeded during recording.

At the end of the call, recording automatically comes to an end. The recording can be played back as a message on the answering machine.

# During a call

## Listening with a second handset

If at least two handsets are logged on, you can listen in to the call of the other handset from your handset, without participating. The selection as to which handset can listen in is made at the handset making the call.

You are in the middle of a call:

1. Press **MM**.
2. Select "Listening 2nd HS".
3. Press **OK**.
4. Select handset 1-6.
5. Press **OK**.

*The ringer of the selected handset sounds.*

On the selected handset:

6. Press **📞**.  
*The call can be listened to.*

### Note:

Listening in is only possible on one handset.

During listening in, local switching functions are deactivated.

## Provider services

With this feature you can use the following provider services during a call, if they have previously been programmed:

1. Press **MM**.
2. Select "Provider services".
3. Press **OK**.

*Available provider services may include the following:*

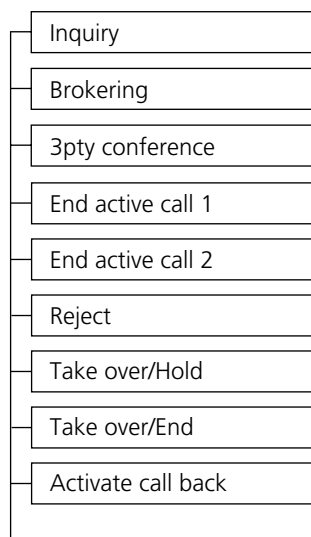

4. **▲, ▼** Select service 1-10 (e.g. brokering).
5. Press **OK**.

### Note:

Depending on your country and provider, different services may be available.

For programming provider services, see section "Adapting provider services".

# Internal calls

## Making calls between two handsets

You can make free internal calls between two handsets, provided you have logged on at least one additional handset (up to max. 6 handsets are possible).

On handset 1:

1. Press .
2. Key in the internal call number, e.g. 2.

On handset 2:



*The internal ringing tone sounds and the caller's number is displayed.*

3. Press .  
*Make your call...*

## Paging from the handset

From the handset you can page (i.e. send a global call to) all logged-on handsets.

From the handset:

1. Press .
  2. Press .
- On all handsets the internal ringing tone sounds and the multifunction key flashes.*  
*The display shows "internal call from HS..".*

## To end paging from the handset

At the logged-on handsets:

1. Press .  
*At the particular handset the internal ringing tone stops; you are now connected to the calling handset.*

## Paging from the base station

From the base station you can page (i.e. send a global call to) all logged-on handsets.

From the base station:

1. Briefly press  on the base station.  
*On all handsets the internal ringing tone sounds and the multifunction key flashes.*  
*The display shows "-PAGING-".*

## To end paging from the base station

At the base station:

1. Press .  
*On all handsets internal ringing stops*

or

at the logged-on handsets:

1. Press .  
*At the respective handsets the internal ringing tone stops.*

### Note:

The paging function activates paging on all logged-on handset.

# Local switching functions

The following pages describe the most often used switching functions available with the base station Top A312/Top A412.

## Internal call waiting

You are in the middle of an internal call when an external call arrives. This external call is signalled by a call waiting tone.

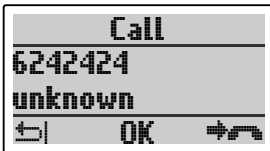

1. You have the following options:
  - Reject the call and continue the current call.
  - OK** Accept the call; the first call is placed on hold.
  - Accept the call; the first call is terminated.

### Note:

A call is only rejected for good if it has been rejected by all logged-on handsets.

## Inquiry

You are in the middle of an internal call and interrupt it to make an inquiry with another call partner.

1. Press .  
*The active call partner is placed on hold.*
2. Dial the internal call number (1-6)
3. Press **OK**.  
*The inquiry is initiated.  
The first call partner is placed on hold.*

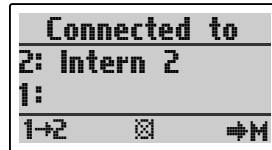

## Alternating between calls (brokering)

You have initiated an inquiry and the display offers **1+2 / 2+1**.

You can now alternate (broker) between two calls as required:

1. Press **1+2 / 2+1**.  
*You alternate between call partners.*

# Local switching functions

## Three-party conference

You are alternating between calls (brokering) and wish to set up a three-party conference (one external and two internal calls or three internal calls). This will allow all three call partners to confer with each other:

1. Press **⇨M**.
2. Select "3pty conference".
3. Press **OK**.

## Return to brokering/end three-party conference

1. Press **H2 / 2+1**.  
*You are now connected with the last call partner again.*

## End brokering

1. Press **⇨M**.
2. Select "End active call".
3. Press **OK**.  
*The connection to the selected call partner is terminated. You are connected to the other call partner again.*

## Call handover/connect

You are in the middle of a call and have initiated an inquiry to another call partner (see "Inquiry"):

*If you are connected to the second call partner (inquiry).*

1. Press .  
*The call is handed over*

or

*if your are not yet connected to the second call partner.*

1. Press .  
*The call is connected.*

## Shortcuts to functions

You can program up to 9 shortcuts. E.g. with the numeric keys 1–9, a shortcut is possible for a function selected by you, provided the function does not require any editing (entry of numbers or letters) or value settings, such as showing call-charges etc. In this way there is no need to find the function via the menu structure (navigating). The application is primarily intended for frequently-used functions and/or functions located in the lower menu levels.

In the default setting, five shortcuts are pre-programmed:

- on number 1: Keypad lock  
(direct activation)
- on number 2: Handset off
- on number 3: Ringer off
- on number 4: Direct call on
- on number 5: Show charges

You can program your own shortcuts on numeric keys 6 to 9 or you can overwrite the already programmed numbers (1–5).

## Programming

The handset is in standby state:

1. Press **✱✱✱**.
2. Press **▲**, **▼** or **◀**, **▶** to select the desired function.
3. Keep the numeric key (1–9) which you wish to program, pressed for approx. 3 seconds.  
*The shortcut is now programmed to this number and the old function is overwritten.*

## Taking a shortcut

The handset is in the standby state:

1. Press **✱✱✱**.
2. Press the desired numeric key.  
*You are now in the respective submenu (function).*

Please make a note of your shortcuts (functions) and the numbers (1–9) assigned to them.

# Provider services

Your Top A312/Top A412 makes it easier for you to use network services. This refers to supplementary services available from the provider (e.g. call waiting). You can use these provider services by assigning the necessary codes as a function (services 1-10) in your telephone.

Please contact your provider for information as some supplementary services need to be applied for and may attract fees.

Via menu guidance you can activate or deactivate those provider services programmed by you either before or during a call. The most common provider services are pre-programmed.

## Call forwarding

This service has already been integrated in the menu guidance. Call forwarding allows you to be within reach even if you are not near your own telephone.

You have the choice of three types of call forwarding:

- |                            |   |
|----------------------------|---|
| <b>Unconditional (CFU)</b> | Incoming calls are forwarded immediately.                                   |
| <b>No reply (CFNR)</b>     | Incoming calls are forwarded after a delay (fixed time or number of rings). |
| <b>Busy (CFB)</b>          | Calls are forwarded if the line is busy.                                    |

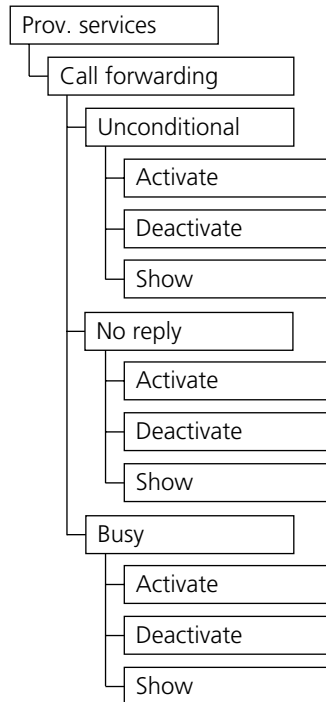

## Activating call forwarding

1. Select type of call forwarding.
2. Press **OK**.
3. Select "Activate".
4. Press **OK**.
5. Enter destination number for call forwarding.
6. Press **OK**.



# Provider services

## Deactivating call forwarding

1. Select type of call forwarding.
2. Press **OK**.
3. Select "Deactivate".
4. Press **OK**.

## Showing call forwarding

For each type of call forwarding (Unconditional, No reply, Busy) you can check whether it is activated.

1. E.g. select "Unconditional".
2. Press **OK**.
3. Select "Show".
4. Press **OK**.  
*A respective message is played if call forwarding is activated.*
5. Press **⏪**.  
*The telephone returns to standby state.*

## Adapting (programming) provider services

For provider services during connection or services without connection, 10 programming locations (services 1-10) are available which you can program yourself. To do so consult your provider. The most commonly used services are already pre-programmed but they can be adapted as required.

### Provider services during a connection

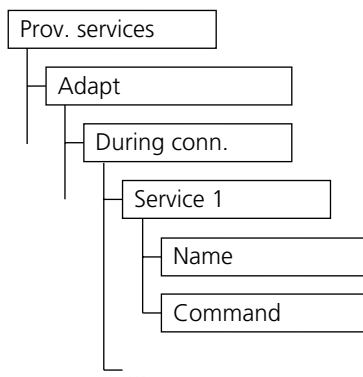

1. Select "During conn.".
2. Press **OK**.
3. Select a service 1-10
4. Press **OK**.
5. Select "Name".
6. Press **OK**.
7. Enter the name of the function. (e.g. 3pty conference).
8. Select "Command".
9. Press **OK**.
10. Enter code for the function "3pty conference".
11. Press **OK**.

## Provider services

The telephone is delivered with the following pre-programmed services (during a connection):

- Service 1 – Enquiry call
- Service 2 – Call switching
- Service 3 – 3-way conference
- Service 4 – End call 1
- Service 5 – End call 2
- Service 6 – Reject
- Service 7 – Accept-Hold
- Service 8 – Accept-End
- Service 9 – Callback on busy
- Service 10 – free

10. Enter code for the function "Activate" (e.g. \*43# call waiting on).
11. Select "Deactivate".
12. Press **OK**.
13. Enter code for the function "Deactivate" (e.g. #43# call waiting off).
14. Select "Show".
15. Press **OK**.
16. Enter code for the function "Show" (e.g. \*#43# show call waiting).

### Provider services without a connection

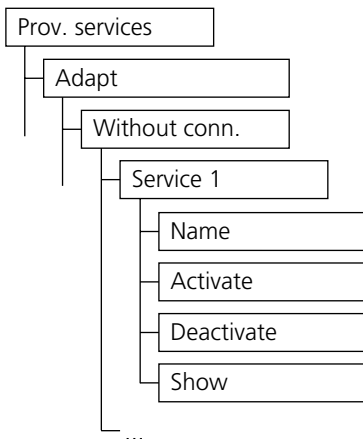

1. Select "Without conn.".
2. Press **OK**.
3. Select a service 1-10.
4. Press **OK**.
5. Select "Name".
6. Press **OK**.
7. Enter the name of the function. (e.g. call waiting).
8. Select "Activate".
9. Press **OK**.

### Note:

Contact your provider for information on available services and their codes for programming.

To change a service already programmed, follow the steps shown in "Provider services" "Adapt" by overwriting existing information.

The telephone is delivered with the following pre-programmed services (without a connection):

- Service 1 – Call waiting
- Service 2 – Callback on busy
- Service 3 – free
- Service 4 – free
- Service 5 – free
- Service 6 – free
- Service 7 – free
- Service 8 – free
- Service 9 – free
- Service 10 – free

# Provider services

## Using more services

Use your adapted services as follows:

### Activate/deactivate/show services without connection

You will need to activate services without a connection before a call, to be able to use them during a call. After the call you can deactivate the service or have it shown at any time.

Handset must be in standby mode:

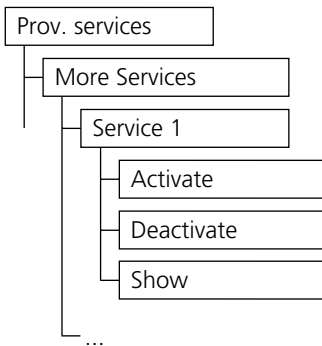

1. Select "More services".
2. Press **OK**.
3. Select a service (e.g. "Call waiting").
4. Press **OK**.
5. Select "Activate", "Deactivate" or "Show".
6. Wait for acknowledgement tone or message from the network.
7. Press .  
*A respective message is played or an acknowledgement tone sounds.*

### Provider services during a connection

See section "During a call".

## Brief description of services (during a connection)

### Enquiry call

You are conducting an internal call and make an enquiry call to a second person. The first call partner is put on hold.

### Call switching

You have initiated an enquiry call and can now switch between the first and second call partners.

### 3-way conference

You are switching between calls and want to set up a 3-way conference call.

All three call partners can now speak to each other. A 3-way conference can only be activated by the calling party.

### End call 1

You are conducting a 3-way conference or switching between calls and want to end the call with the first call partner.

### End call 2

You are conducting a 3-way conference or switching between calls and want to end the call with the second call partner.

### Reject

This service can only be used if "Call waiting" (without a connection) is activated.

If a second call partner tries to call you while you are conducting another call, a signal tone is emitted for 20 seconds to alert you to the second call. You can choose to reject the waiting call.

## Provider services

### **Accept-Hold**

This service can only be used if "Call waiting" (without a connection) is activated.

If a second call partner tries to call you while you are conducting another call, a signal tone is emitted for 20 seconds to alert you to the second call. You can accept the waiting call. The first call partner is put on hold.

### **Accept-End**

This service can only be used if "Call waiting" (without a connection) is activated. If a second call partner tries to call you while you are conducting another call, a signal tone is emitted for 20 seconds to alert you to the second call. You can accept the waiting call. The first call is ended.

### **Callback on busy**

If the line you are trying to call is busy, you can program an automatic callback while you hear the busy tone. If the line becomes free within the next 30 minutes, the network automatically calls you back and offers to connect you to the number you dialled originally.

See also under "Blue key".

## **Brief description of services (without a connection)**

### **Call waiting**

You can check whether you have activated "Call waiting" and can deactivate this service again.

### **Callback on busy**

You can check whether you have activated "Callback on busy" and can deactivate this service again.

### **Note:**

You can use the blank services to program your preferred services or overwrite services already programmed. All services can be activated or deactivated according to your requirements. For further information, contact freephone 0800 800 800 or ask for documentation on Swisscom supplementary services.

# Provider services

## Combox

Depending on your provider, an answering machine on the network is available to you. If you use it, you can save its access number.

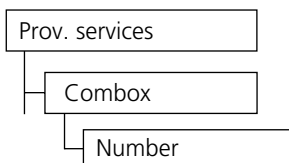

### Programming

1. Select "Combox".
2. Press **OK**.
3. Select "Number".
4. Press **OK**.
5. Enter the respective number.
6. Press **OK**.

### Note:

Once you have finished programming, you can directly dial Combox by holding down key 1.

Speed-dial key 1 is reserved for the Combox (see above for programming).

## Blue key

If the line you are trying to call is busy, you can program an automatic callback by pressing the blue key. The network will automatically call you back when the line becomes free.

### Activating

Busy tone is heard:

1. Press ☺.  
"Callback on busy" is activated.

### Programming

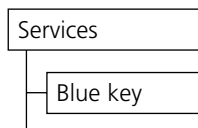

1. Select "Blue key".
2. Press **OK**.
3. Enter the relevant number.
4. Press **OK**.

### Note:

The "Callback on busy" supplementary service is not universally available. Both the caller and the called party must be connected to an exchange that supports this supplementary service.

# Advice of charge and call duration

During outgoing calls your telephone displays the charge and duration of each call provided your provider supplies the tax pulses. For technical reasons the details on your telephone bill may differ from the values displayed on your telephone. The amount billed by the network operator is binding.

## Setting the factor

Set the factor for a time unit per handset and for the exchange (system):

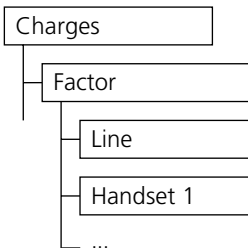

1. Select "Line" or "Handset 1–6".
2. Press **OK**.
3. Enter factor (insert decimal point using **\*** or **#** key).
4. **↵** Correct if necessary.
5. Press **OK**.

## Setting the currency

Set the currency in which you wish charges to be displayed:

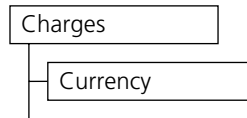

1. Select "Currency".
2. Press **OK**.
3. Enter "Currency" (e.g. Fr.).
4. Press **OK**.

### Note:

When the currency is entered for the first time or changed, the individual entry (last call) and total are deleted.

# Advice of charge and call duration

## Displaying/deleting totals

The total for all calls as well as the amount of the last call can be displayed or deleted at any time.

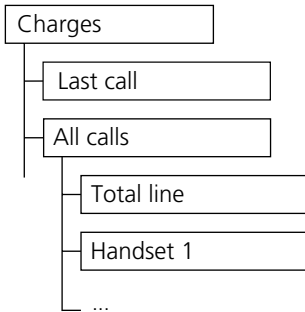

1. Select e.g. "Handset 1".
2. Press **OK**.  
*Amount is displayed.*
3. Press **OK**.  
*Display is cancelled.*  
or
4. Press **⇨**.  
*Amount reset to zero.*

## Display type

You can select whether to display charges and/or call duration:

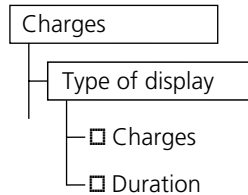

1. Select "Type of display".
2. Press **OK**.
3. Select "Charges" or "Duration".
4. Press **OK**.

## Using several handsets

The telephone allows you to operate up to 6 handsets on one base station. You can make two internal calls between two handsets and at the same time one subscriber can also make an outside call. Each additional handset must be logged onto the base station and allocated an internal number. Each internal subscriber number (1-6) can only be allocated once. It is shown on the handset display in standby state.

### Note:

If during operation with several handsets one of the handsets has already seized the external line, the busy tone sounds in the second handset. You can still make internal calls. Each handset can be logged on at up to 4 base stations (A–D).

## Preparing the base station for log on

- Press the internal key at the base station for five seconds.

*The connection indicator on the base station (red light 1) starts flashing.*

*For 60 seconds the base station is now ready to enable you to log on a handset.*

## Logging a handset on

If the base station has been prepared, you can log the handset on the base station:

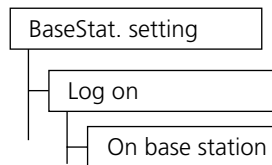

1. Key in the base station PIN or "0000" (default setting).
2. Key in the new internal call number (1–6) for the handset.
3. Determine the designation of the base station (A–D).
4. Press **YES**.

If log on was successful, the respective letter (A–D) appears on the base station display.

### Note:

If the internal call number is seized a second time, the handset first logged onto it is logged off.

If the logging-on process fails, the respective letter on the base station display continues to flash.

In order to log a handset on you need to be within range of the base station.

## Logging on via paging key, Top A412

To log on via the paging key, you must hold the key down for at least 5 seconds until the second signal tone is heard (in the case of the Top A312, after the first signal tone is heard) and the LED is flashing rapidly. The base station switches to log-on mode.



# Using several handsets

## Logging a handset onto another base station (GAP)

To log your handset onto a third-party base station (other base station), the handset must support the GAP generic access profile.

Follow the manufacturer's instructions when preparing the other base station for log on.

Prepare the handset:

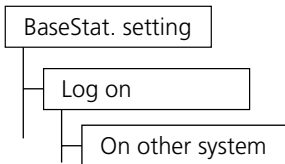

1. Enter the 4-8 digit access code (AC) of the previously prepared base station (e.g. 12345).
2. Key in the designation of the base station (A–D).
3. Press **YES**.
4. Log the other handset on according to its instructions.

### Note:

The base station assigns the internal number for the handset automatically. The base station letter (e.g. A) appears in the display to confirm that log on was successful.

If log on was unsuccessful, an error tone sounds and the letter A flashes.

GAP functions are described in the section "GAP uses".

## Logging another handset onto the base station (GAP)

A third-party handset (other handset) must support the GAP generic access profile in order to be logged onto your base station.

Prepare the base station using the handset:

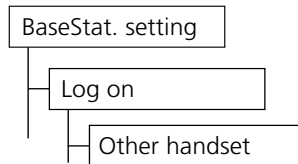

1. Specify a 4 to 8 digit access code (AC), (e.g. 12345).
2. Key in the new internal number (1–6) of the other handset.
3. Press **YES**.
4. Log the other handset on according to its instructions.

### Note:

If the internal number used has previously been allocated for logging on, the handset first logged on will be logged off.

# Using several handsets

## GAP uses

Your telephone supports the multi-vendor DECT GAP protocol (GAP = Generic Access Profile). To be able to log it onto another base station, the latter must support the GAP protocol.

Among others the following functions are available:

- Outgoing calls from the handset
- Taking incoming calls
- Internal calls from handset to handset

## Logging a handset off from a base station

To log a handset off from a base station:

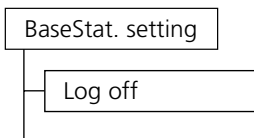

1. Select the handset which you want to log off.
2. Press **OK**.  
*Successful log off is signalled in the display.*

### Note:

To log a handset off, you must be in the vicinity of the base station. You can only log off other handsets using the handset Top A312/Top A412, not using the other handset itself.

# Using several handsets

In addition to your own base station, you can operate your handset on up to three further base stations.

## Application example

You have a telephone at home and use an identical handset at your workplace. You can now also use the handset from the cordless telephone at work on the base station at home and vice versa. Of course, incoming and outgoing calls are possible only within the range of the particular base station. There is no handover to another base station (Roaming).

## Specifying the configuration

The handsets must be logged onto the base station at home and onto the base station at work. Specify one letter (A, B, C or D) in each case for the base station at home and one for the base station at work. Next allocate one internal subscriber number (1 to 6) to each of your handsets.

### Note:

The radio cells can overlap partly. Incoming calls will only be forwarded to your handset if the corresponding base station is selected.

If the handset is not in radio contact with the base station, the corresponding letter will flash in the display.

## Selecting a base station

Outgoing calls can be made from any of the base stations.

If the radio cells overlap, the connection is established with the base station shown on the handset. You can always only be contacted via the base station shown in the display.

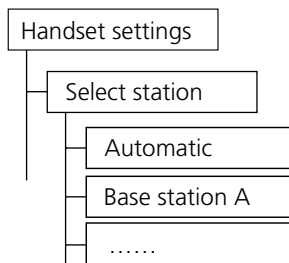

### Automatic

In the default setting the handset always automatically dials up via that base station in whose range it is located.

### Base station A, B, C or D

You have the option of setting your handset to a particular base station. The handset will then always dial only via this particular base station and you can only be reached via this base station.

## Direct call (babyphone feature)

When direct call (babyphone feature) is activated, a destination number is dialled by pushing any key except for the menu key. When direct call is activated, calls can be taken in the usual way.

### Activating direct call

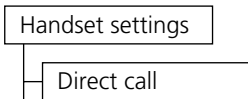

1. Select "Direct call".
2. Press **OK**.
3. Enter destination number.

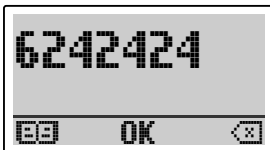

4. Press **OK**.  
*The display shows "----DIRECT CALL----*"

#### Note:

If a number is already stored it will be displayed.

### Initiating a direct call

1. Press any key, except for the menu key.  
*The direct call number stored is dialled automatically.  
Make your call...*
3. Press .  
*The call is terminated.  
After a few seconds "----DIRECT CALL----" appears in the display again.*

#### Note:

We recommend that you check the number you have keyed in by making a test call.

### Deactivating direct call

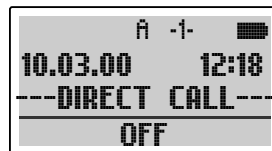

1. Press **OFF**.
2. Press **YES**.  
*Direct call is deactivated.*

# Keypad lock/ringer off

In standby state under  you can use the following two handset functions

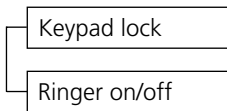

## Keypad lock on

You can switch the keypad lock on to prevent unintended pressing of keys having an effect:

1. Select "Keypad lock".
2. Press **OK**.  
*The keypad is locked.  
Incoming calls are signalled and can be taken by pressing the connect key.*

## Keypad lock off

For outgoing calls, the handset must be switched from the lock state to the standby state:

1. Press **OFF**.
2. Press **YES**.  
*The keypad lock is off.*

## Ringer off

You can switch the ringer off on the respective handset so as not to be disturbed:

1. Select "Ringer off".
2. Press **OK**.  
*The ringer on the handset is switched off.  appears in the display and the multifunction key flashes. A call is only signalled in the display and can be answered in the usual way.*

### Note:

The ringers of the base station and of other handsets remain on.

## Ringer on

1. Select "Ringer on".
2. Press **OK**.  
*The ringer on the handset is switched on again.*

## Handset settings

You can set your handset to meet your personal requirements, as follows:

### Switching the handset on/off

You can switch your handset off to maintain the capacity of the batteries for a longer period:

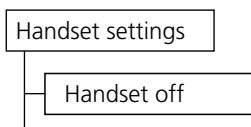

1. Select "Handset Off".
2. Press **OK**.  
*The handset is off. Incoming calls are not signalled.  
The display is inactive.*
3. Press .  
*The handset is now on again.*



#### Note:

The base station signals incoming calls whether the handset is on or off.

### Setting the language

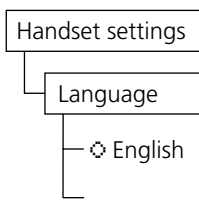
For menu guidance you can select your preferred language:





1. Select "Language".
2. Press **OK**.
3. ,  Select the desired language.
4. Press .  
*Menu guidance changes to the new language.*

### Selecting the battery type

The telephone is supplied with three rechargeable batteries. If you use different batteries from those supplied, be sure that the battery type is set to NiMH or NiCd as appropriate.

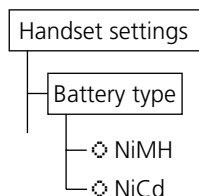
If you change the type of batteries used, you will need to select the applicable battery type:



1. Select "NiMH" or "NiCd".
2. Press .

#### Note :

If the handset is programmed to the wrong battery type, the batteries may be damaged or their available capacity may not be used. The capacity of NiMH batteries is greater than that of NiCd batteries.

# Handset settings

## General settings

The following handset settings can be switched on or off.

Select the respective function and switch it on or off by pressing the menu key below /.

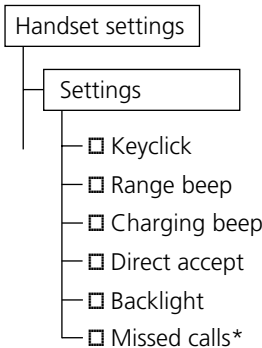

## Keyclick

Each keystroke on the handset is confirmed by an click. In the default setting, keyclick is on.

## Range beep

If the range beep is on, a warning beep sounds if you leave the radio range.

If this happens, move back towards the base station or out of the blind spot until the warning beep stops, otherwise the telephone link will be cut.

### \*Note:

Functions only in specific PBXs with activated CLIP.

### Note:

If the range is inadequate, relocation of the base station may bring about an improvement. See the section "Setting up the telephone and putting it into service" for information about the optimum location.

## Charging beep

In the default setting, the charging beep is on; an acknowledgement beep sounds when the handset is replaced in the charging bay.

## Direct accept

Incoming calls are accepted directly, simply by lifting the handset from the base station or from the charging bay.

### Note:

If the handset is neither in the base station nor in the charging bay the calls can be accepted by pressing the connect key. While the answering machine is recording a message, direct accept is temporarily deactivated.

## Backlight

The function "Backlight" can be switched on or off. If it is on, the display is backlit as soon as any key is pressed or a call arrives. If no key is pressed for several seconds, backlight switches off automatically.

# Handset settings

## Handset ringer

You can select the volume and the melody.

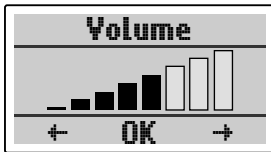
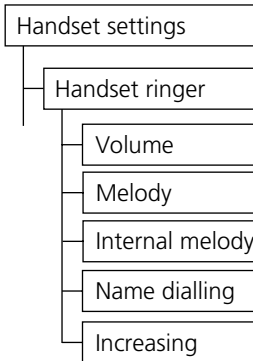

1. E.g. select "Volume".
2. Press **OK**.
3. **←, →** Select your settings.  
*The selected setting is played back continuously for you to check.*
4. Press **OK**.  
*The settings are saved.*

### Note:

Please note that full volume may damage your hearing.

## Increasing

You can set the volume to "Increasing", i.e. the ringer starts at the lowest volume level, increasing to the set level:

1. Select "Increasing".
2. Press **OK**.

### Note:

Please note that full volume may damage your hearing.

If the volume is set to 3 or higher an the function "Increasing" is disactivated, the fist and second ring starts at level 3 and up from the third ring with the set volume.



# Handset settings

## Handset PIN

The handset PIN (personal identification number) is required if you want to disable individual operating options (resetting to the default settings, deleting the directory etc.) and to protect them against unauthorised access. In the **default** setting (factory setting) the handset PIN is switched off ("0000").

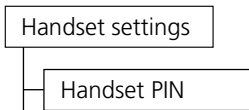

1. Select "Handset PIN".
2. Press **OK**.
3. Enter 4-digit PIN.
4. Press **OK**.
5. Repeat 4-digit PIN.  
*The handset PIN is activated.*

### Note:

Please remember your handset PIN. If you forget it the services of your dealer will be required at your expense.

# Base station settings

## Base station ringer

You can select the volume and the melody

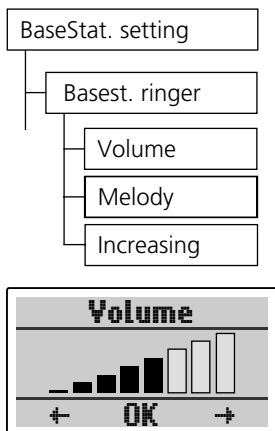

1. Select "Volume" or "Melody" or "Increasing".
2. Press **OK**.
3. **←**, **→** select your setting.
4. Press **OK**.

### Note:

If the procedure is terminated with the connect key or the cancel key, the old setting is retained.

Please note that full volume may damage your hearing.

## Time and date

When you first operate the telephone or after a power failure, date and time will not be correct. You can set them manually:

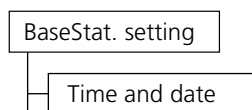

1. Enter the time (e.g. 18:54).
2. Enter date (DD.MM.YY).

# Base station settings

## Base station PIN

The base station PIN (personal identification number) is required if you want to protect individual user options from unauthorised access (e.g. logging off handset etc.). By **default**, base station PIN is off ("0000");

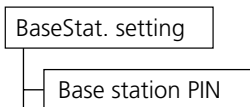

1. Select "Base station PIN".
2. Press **OK**.
3. Enter 4-digit PIN.
4. Press **OK**.
5. Repeat 4-digit PIN.  
*The base station PIN is activated.*

### Note:

Please remember your base station PIN, otherwise the services of your dealer will be required at your expense.

## Call allocation

An incoming external call arrives at the base station. The external call is only switched to those handsets where call allocation is on. The other handsets can only be reached internally. By default, call allocation is on.

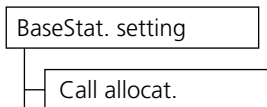

1. Select "Call allocation".
2. Press **OK**.
3. Enter system PIN if necessary.
4. Select handset 1–6.
5. Press **OK**.  
*Call allocation for this handset is on or off.*

# Base station settings

## PBX

When operating the telephone on a private branch exchange (PBX), its characteristics must be taken into account. For further information consult the operating instructions for your PBX.

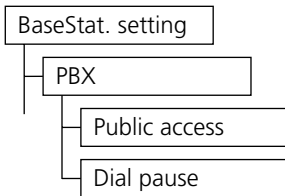

## Setting the dial pause

You can specify the pause required after the exchange code. Please refer to the operating instructions for your PBX.

1. Select "Dial pause".
2. Press **OK**.
3. Specify the dial pause.
4. Press **⊗**.

Your telephone will now automatically insert a dial pause after the exchange identification code, provided no dial tone is recognised.

## Public access code

The public access code is dialled before the telephone number if the telephone number is at least 6 digits long.

In the case of direct dialling (without dialling preparation), no additional public access code is dialled.

1. Select "Public access".
2. Press **OK**.
3. Enter up to 4 digits.
4. Press **OK**.  
*The public access code is now stored.*

## Service function

### Babyphone

You can use one handset as a babysitter (monitoring handset) and monitor a room, i.e. a child's bedroom, for noises. To do this you need two handsets, both logged onto the base station.

As soon as the preset noise level is exceeded, the monitoring handset automatically makes an internal call to the destination handset. You can select one of 3 noise levels.

The destination handset automatically takes the call. The noise can be heard via the speaker of the destination handset.

For external destination handsets the call must be manually accepted.

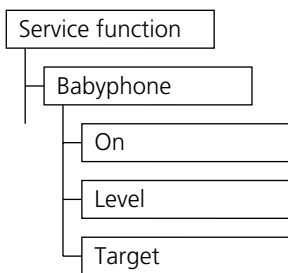

### Programming the babyphone

1. Press **➔M**.
2. Select "Service functions".
3. Press **OK**.
4. Select "Babyphone".
5. Press **OK**.
6. Select "Destination".
7. Press **OK**.
8. Select "Internal destination" or "External destination".
9. Press **OK**.
10. Select the internal destination (handset 1–6).  
Press **✳** or enter an external number.
11. Press **OK**.
12. Select "Level".
13. Press **OK**.
14. Set noise level (1–3)  
1 = low, 2 = medium, 3 = loud
15. Press **OK**.

#### Note:

The interval between one monitoring call and the next is at least 7 minutes if the noise is still above the set level.

### Switching babyphone on

1. Press **➔M**.
2. Select "Service functions".
3. Press **OK**.
4. Select "Babyphone".
5. Press **OK**.
6. Select "On".



*Monitoring via the babyphone feature is on.*

# Service function

## Switching babyphone off

On the monitoring handset:

1. Press **OFF**.  
*Babyphone monitoring is off.*

### **Note:**

Place the monitoring handset within approximately 1–3 meters of the child. Only one destination handset can be defined.

Incoming calls are not displayed on the monitoring handset if the destination is defined as internal.

If the external destination number is busy, it is redialled after a defined time.

The call must be terminated by the external user.

Both handsets must be within range and the battery cells must be charged up.

### **Recommendation:**

The "Babyphone" function should be simulated every time before it is used.

On the monitoring handset all acoustic signals need to be off (e.g. radio signals). If both handsets are in the same room, this may produce undesirable feedback.

### **Warning:**

Swisscom accepts no liability in case of a malfunction of the babyphone feature.

## Service function

### Transferring directory entries to other handsets

When you have logged on two or more handsets to your base station you can transfer the entire directory or individual entries from one handset to another. This exchange is only possible within the maximum limit of 6 handsets (Top A312/Top A412) on your base station.

### Before the transfer

Before you start the transfer you should ensure that the receiving handset which is to receive the data:

- is switched on
- is logged on
- is within range of the mutual base station
- is not maintaining an active connection

### Transmitting entries

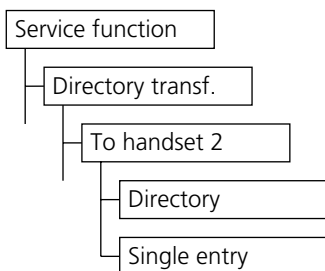

At the transmitting handset:

1. Select "Directory transf."
2. Select the number of the receiving device.

3. Select "Entry" to transmit a single entry only, or "Directory" to transmit all entries.

*The connection is established.*

*The message "Prepare handset 2" appears.*

4. Select an entry.
  5. Press **OK**.
- Transfer starts.*

### Receiving entries

At the receiving handset:

- The handset must be on.

1. Within 60 seconds reply **YES** to the message "Directory transf., from handset 1".

#### Note:

- If you have sent an individual entry you can immediately select a further entry and transfer it.
- If necessary enter the PIN of the receiving handset.
- Already existing entries are not overwritten; they are stored twice.
- During transfer of the entire directory, the message "Delete the directory? YES/NO" appears.
  - If you press **YES**, first your entire present directory content is deleted; then the transfer commences.
  - If you press **NO**, the transfer ends and the handset returns to the standby state.

# Service function

## Selecting providers

Your telephone supports you with several options when selecting the most economical connection.

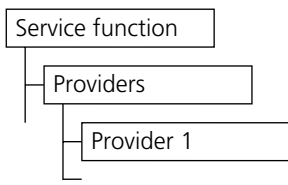

In the menu "Providers" you can store up to 5 service providers with names and network prefixes (provider numbers).

1. Select "Providers".
2. Press **i**.
3. Enter the network prefix.
4. Press **OK**.
5. Enter the name of the provider.
6. Press **OK**.
7. Select one of the following options:

**Nothing** The provider is only acquired and has no function. The provider can be associated with a directory entry.

**Always** Unless other provider functions are defined, all call numbers will be selected via this provider.

**Conditional** Enter a prefix, e.g. 00 for international calls. All call numbers starting with these numbers will be directed via this provider.

### Note:

If several providers are active, the provider is selected according to the following priority:

1. Option specified in the directory entry.
2. Destination prefix for certain numbers (e.g. 079, 0171, 00).
3. Provider option "Always", can only be activated for one provider.

Via the option of joining numbers in off-line call preparation, you can determine for each individual call which provider is to be dialled (see section "Off-line call preparation").



# Service function

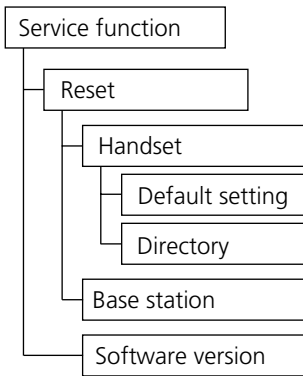

## Resetting the handset to the default setting

This procedure resets all settings on the handset to the default setting. Directory entries, PIN code, and the log on of the handset remain saved:

1. Select "Handset".
2. Press **OK**.
3. If necessary, enter PIN.
4. Press **OK**.
5. Select "Default setting".
6. Press **OK**.
7. Press **YES**.

## Resetting the directory

This procedure deletes the directory entirely:

1. Select "Handset".
2. Press **OK**.
3. If necessary enter PIN.
4. Press **OK**.
5. Select "Directory".
6. Press **OK**.
7. Press **YES**.

## Resetting the base station to the default setting

This procedure resets all settings on the base station to the default setting.

1. Select "Base station".
2. Press **OK**.
3. If necessary enter PIN.
4. Press **OK**.
5. Press **YES**.

The handsets remain logged on.

## Software version

Shows the software version of handset and base station:

1. Select "Software version".
2. Press **OK**.
3. Select "Handset" or "Base station".
4. Press **OK**.

# Setting the answering machine

## Introduction

**This section applies only if you have an Top A412 (with answering machine).**

The answering machine is controlled exclusively via the handset.

It can only be switched on or off from the base station.

Thanks to the standard outgoing message (plug & play) your answering machine is immediately operational. All you need to do is to switch it on.

The answering machine can be operated from the base station, the handset or by remote access via the network. If the answering machine is operated from the handset, the display indicates the number of the incoming message stored, the time and date it was left, and the telephone number of the caller.

## Functions

- There are two different operating modes:
  - Outgoing message with recording
  - Answer only without recording
- The number of rings after which the answering machine switches itself on can be set to between 2 and 9 rings or to "Economy function"
- Enable or disable operation of the answering machine using remote access
- Standard outgoing message (preprogrammed outgoing message)
- Monitoring of incoming messages
- Adjustable length of incoming messages

### **Note:**

Recording of the outgoing message is limited to 30 seconds.

## Characteristics

- Total recording time up to 22 minutes
- Automatic recording quality, i.e. the recording quality drops as the length of the recording time increases.
- Digital recording
- No maintenance required

### **Note:**

Your answering machine cannot work if there is a power failure; however, the messages previously left and the outgoing messages remain saved.

## Date and time

Your telephone registers time and date of the recorded messages and shows this information in the handset display. To set time and date, see the section "Base station settings".

# Setting the answering machine

## Setting the number of rings

You can set the number of rings after which the answering machine switches itself on to between 2 and 9 rings or to "Economy function".

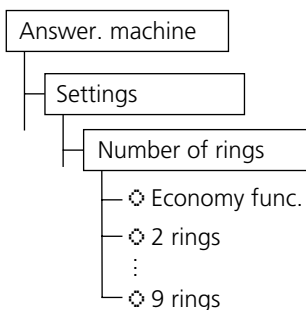

1. Select the desired number of rings.
2. Press ⊗.

In "Economy function" (default) the answering machine switches itself on after:

- Four rings if no new messages have been recorded
- Two rings if new messages have been recorded

### Note:

When polling your answering machine from a distance (remote access), you can hang up after the third ring because no new messages have been recorded. This helps you save telephone charges ("Economy function" setting).

## Activating/deactivating message monitoring

You can listen to all incoming messages via the loudspeaker on the base station.

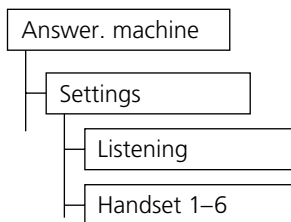

1. Select handset 1-6
2. Press ⊗.  
*Listening in is activated for the corresponding handset.*

### Note:

See also the section "Listening to/taking over incoming calls" (handset).

## Time limit

The duration of each incoming message can be set as follows:

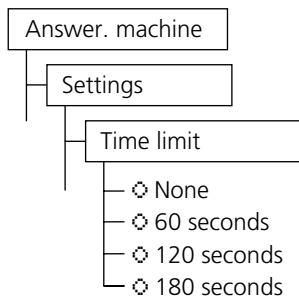

Press ⊗.

# Setting the answering machine

## Operating modes

You can use the answering machine in two modes by selecting the respective outgoing message:

- **Record messages**

Following outgoing message A or the standard outgoing message, the caller can leave a message.

- **Answer only**

Only a brief comment is played (outgoing message B), e.g. saying that you are presently unavailable. The caller cannot leave a message.

## Selecting an operating mode

The operating mode selected remains set until you select another outgoing message.

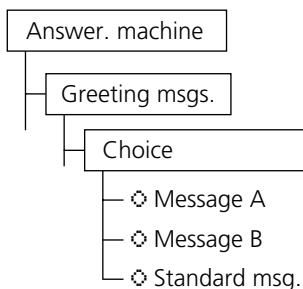

### Record messages

1. Select "Message A" or "Standard msg.".
2. Press **⊗**.  
*The set outgoing message is played.*

### Answer only

1. Select "Message B".
2. Press **⊗**.  
*Outgoing message B is played.*

### Note:

When the memory is full the answering machine automatically switches itself off and "Answ. mach. Full" appears in the display.

In the "Recording" mode, the time-over message, if recorded and switched on, is played after a set period.

## Setting the language of the standard message (plug & play)

You can set the programmed message in a language of your choice:

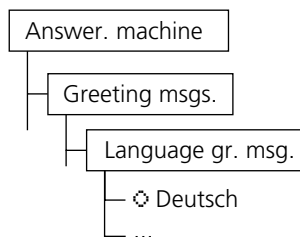

1. Select "Language gr. msg.".
2. Press **OK**.
3. Select the desired language.
4. Press **⊗**.

# Setting the answering machine

## Time-over message

You can record a time-over message (e.g. "Thank you for calling") and switch it on or off. If it is on, it will be played after expiry of the time limit set for a message.

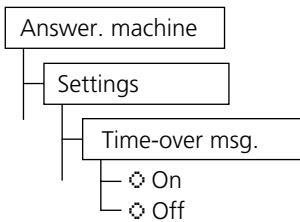

1. Select "Time-over msg." .
2. Press **OK**.
3. Press "On" or "Off" .
4. Press **⊙**.

# Operating the answering machine from the handset

## Introduction

You can operate your answering machine from any logged on Top A312/Top A412 handset:

- Switch on/off
- Record/change your outgoing messages
- Play back and delete messages

## Switching the answering machine on/off

Depending on the functions, the answering machine must be switched on or off.

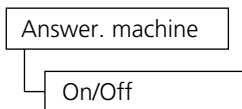

If no outgoing message has been recorded, the standard message (plug & play text) is activated when the answering machine is switched on.

## Recording an outgoing message

You can record your own outgoing messages.

The answering machine must be off:

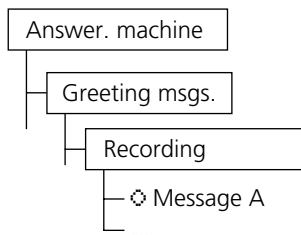

1. Select "Message A" or "Message B" or "Time-over msg.".
2. Press  $\odot$ .



3. Press **START**.  
After the beep, record the text ... (min. 5 sec., max. 3 min.). Speak without making long pauses (max. 4 sec.) otherwise recording will end.
4. Press **STOP**.  
*The recording procedure is now finished. The text you have just recorded is saved and replayed for you to check.*

### Note:

Choosing an outgoing message see "Changing the operating mode/monitoring the outgoing message".

# Operating the answering machine from the handset

## Deleting an outgoing message

The answering machine must be off:

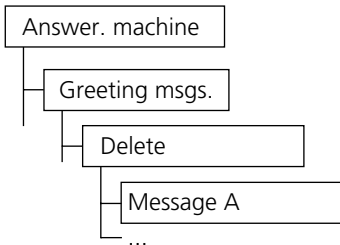

1. Select "Message A" or "Message B" or "Time-over msg. ".
2. Press **⊗**.  
*The outgoing message is now cleared.*

## Changing the operating mode/ monitoring the outgoing message

You can monitor your outgoing message and also keep changing it. Whenever the outgoing message is changed, the message you have just set is played back for confirmation.

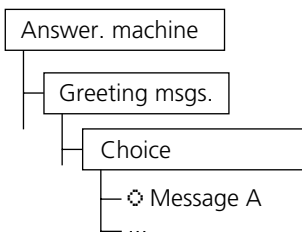

1. Select the desired outgoing message.
2. Press **⊗**.  
*The respective outgoing message is played.*

### Note:

To finish monitoring, press the "Cancel" key **ⓐ**.

## Displaying new messages

As soon as any new incoming messages have been recorded on your answering machine, this is shown in the display.



1. Press **OK**.



*The first new message is played. The icon **ⓐ** disappears from the display*

or

Press **ⓐ**.  
*The handset returns to standby state. The icon **ⓐ** in the display indicates that there are new messages on the answering machine.*

# Operating the answering machine from the handset

## Playing back recorded messages

You can play back new messages or previously played back messages on the answering machine as follows:

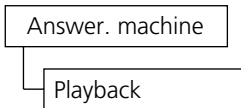

1. Select "Playback".
2. Press **OK**.  
*The messages are played back.*



Instead of **New message 1**, the following messages may appear:

- **New message 2** if new message 1 has already been played back
- **Old message 1**, if there are no new messages

1. Press **⏮**.  
*The messages are played through the handset. If there are new messages, first the oldest new message is played back. If there are only messages which have already been played back, the machine begins by playing back the oldest message.*

## During playback

### Jump forward to the next message

1. Press **⏭** (Forward).

### Repeat current message

1. Press **⏮** (Rewind)

### Jump back to the previous message

1. Press **⏮** (Rewind) twice in quick succession.

### End playback

1. Press **⏹** (Cancel).

## Deleting messages

### Deleting individual messages

An individual message can only be deleted while that message is being played back.

You are playing back a message and want to delete it:

1. Press **⏹**.  
*This message is now deleted. Playback continues with the next message.*

### Deleting all played back messages

With this procedure you can delete all completely played back messages together.

The answering machine must be off:

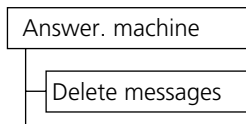

1. Select "Delete messages".
2. Press **YES**.  
*All completely played back messages are now deleted.*



# Operating the answering machine from the handset

## Active answering machine ("Pick up")

If the answering machine has accepted an incoming call and the handset is not engaged, the two devices switch to "pick-up" mode. In this mode the call can be directly picked up:

The answering machine is switched on. The outgoing message is played or the caller leaves a message.

1. Press the Talk key or .



### Note:

If "Call screening" is activated, the outgoing message as well as the caller's message are played over the loudspeaker. Pressing the C key (or the  key) returns the machine to standby and call screening is aborted. The answering machine continues to record the message.

## Temporary call screening

Even if "Call screening" is switched off, you can listen to incoming messages over the handset without the caller hearing you.

The outgoing announcement is played and the caller speaks his message.

1. Press .
2. Press .  
*Call screening is switched off.*

### Note:

The message is saved even if call screening is on.

## Recording telephone calls

When making a call you have the option of recording the entire call or parts of it. See section "During a call".

## Checking the time left for recording

You can check the recording time left until the memory is full:

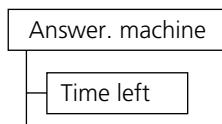

1. Select "Time left".  
*The time left for recording is shown.*
2. Press **OK**.

# Operating the answering machine from the base station

## Answering machine on/off

### On

Answering machine is off.

Press ● until the signal tone is heard.

*The red lamp is on.*

*The answering machine is switched on.*

### Note:

If the answering machine cannot be switched on, the memory may be full. This is indicated by the red lamp double-flashing rapidly (delete at least one message).

### Off

The answering machine is switched on.

The red lamp is on.

Press ● until the signal tone is heard.

*Answering machine is off.*

# Operating the answering machine by remote access

## Introduction

You can remotely control your answering machine from any telephone or mobile phone:

- Switch on/off
- Record/modify/select your outgoing messages
- Play back and delete messages

DTMF signals are required for remote control of your answering machine. Remote control can be via a telephone with tone dialling (DTMF), a mobile phone or a code transmitter (manual transmitter).

### Note:

Remote access is automatically cut off if no function is carried out within 24 seconds.

## Remote access PIN

Your remote access PIN is required if you want to activate remote access on your answering machine.

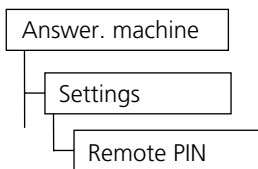

1. Select "Remote PIN".
2. Press **OK**.
3. Enter 4-digit PIN.
4. Press **OK**.

### Note:

In the default setting, remote access is deactivated. Please remember your new remote access PIN. If you forget it the services of Swisscom will be required at your expense.

To bar the remote access PIN, enter "0000".

### Points to remember when using remote access

All functions can be cancelled or stopped with numeric key 2.

To end remote access, replace the receiver or disconnect the call on your mobile phone.

# Operating the answering machine by remote access

## Access via remote access

### With the answering machine on

1. Dial the number of your telephone.
2. Temporarily switch the telephone to tone dialling (DTMF), if not already set, or place a DTMF code transmitter up to the mouthpiece.  
*The outgoing message is now played back.*
3. During the outgoing message enter your personal remote access PIN.  
*The message is now interrupted.  
The ready beep sounds.*
4. You can now operate the answering machine by pressing the numeric keys.

### With the answering machine off

1. Dial the number of your telephone.
2. After 10 to 12 rings the answering machine switches itself on (warning beep) for 8 seconds without playing an outgoing message.
3. Enter your remote access PIN.  
*The ready beep sounds.*
4. You can now operate the answering machine by pressing the numeric keys.

## PIN alarm

If you enter the remote access PIN incorrectly, an error tone sounds. You will then need to key in your remote access PIN once again. Remote access is **always** protected, i.e. if you enter the remote access PIN incorrectly three times in succession, your telephone will automatically disconnect the line. The PIN alarm is then activated (indicated by rapid flashing of the red light). It is now impossible to remote access your answering machine until the PIN alarm has been reset by pressing the On/Off key at the base station.

### Note:

If the red light continues to flash rapidly, the answering machine is full (delete at least one message).

## Switching the answering machine on/off

Press **4**.  
*The answering machine is now on and the outgoing message is played.*

Press **4**.  
*The answering machine is now off and an acknowledgement beep sounds.*

### Note:

If no outgoing message is played, the answering machine was unable to switch itself on because the memory is full (delete at least one message) or message B (play back message) was not recorded properly.

# Operating the answering machine by remote access

## Playing back recorded messages

Press **3**.

*The recorded messages are played back. New messages are played first. If there are no new messages, the machine begins by playing back the oldest message.*

## During playback

### Repeat current message

Press **1**.

### Jump back to the previous message

Press **1 7**.

### Jump forward to the next message

Press **3**.

### End playback

Press **2**.

### Delete the current message

Press **0**.

## Functions with the answering machine switched on

### Select the operating mode/outgoing message

The answering machine is off:

Press **4**.

*The answering machine is switched on and the current outgoing message is played back for checking purposes.*

During the playback:

Press **1** (message A)

or

Press **3** (message B)

or

Press **6** (standard message)

or

Press **9** (time-over message)

*The respective outgoing message is set and played back.*

### Note:

If you press **9** the time-over message is activated and played back without any change in the operating mode. By pressing **9** again the time-over message is deactivated.

# Operating the answering machine by remote access

## Functions with the answering machine off

If necessary switch the answering machine off:

Press **4**.

### Delete all played back messages

Press **0 7 0**.

### Record an outgoing message

Press **5 1** (message A)

or

Press **5 3** (message B)

or

Press **5 9** (time-over message).

After the beep, record the text (min. 5 sec., max. 3 min.). Speak without making long pauses (max. 4 sec.) between words, otherwise recording will end.

### End recording

Press **2**.

*The text just recorded is played back for you to check.*

### End monitoring

Press **2**.

### Delete an outgoing message

The answering machine is off:

Press **0**.

*A warning tone sounds.*

Press **1** within 3 seconds.

*Message A is now cleared.*

or

Press **3** within 3 seconds.

*Message B is now cleared.*

or

Press **9** within 3 seconds.

*The time-over message is now cleared.*

# General information

## Troubleshooting

Most malfunctions will not be the result of a defect in your telephone. You can often correct minor faults yourself by switching off/on the plug-in power supply of the base station or removing the batteries of the handset and inserting them again.

The following tips are intended to help you do this.

Symptom	Cause	Remedy
No display.	Handset not switched on. Batteries discharged or inserted incorrectly.	Press connect key. Charge handset/ batteries.
No radio link to the base station.	Handset not logged on.	Log handset on.
Cannot get a line, no dial tone.	Telephone connector plug plug not correctly inserted.  Plugs of the AC adaptor not correctly inserted.	Check the plug at both the telephone socket and the base station; if necessary remove and reconnect.  Check the plug at both the telephone socket and the mains plug at the 230V socket. If necessary remove and reconnect.
Handset and/or base station not ringing.	Ringer de-activated or set too low.	Adjust ringer volume.
On PBXs only: No connection or wrong number when dialling from speed-dial memory.	Exchange identification code not entered.	Enter exchange identification code.
Handset not ringing when an external call arrives.	Ringer is switched off. Volume is on minimum. Babyphone is switched on. Call allocation is switched off.	Switch ringer on. Adjust volume. Switch babyphone off. Switch call allocation on.

**Important:** Problems or faults can only be corrected if you take the complete device (base station, handset and connection cable) to the sales outlet!

# General information

## Repair and Maintenance

### Leased device

In the event your telephone does not function properly, please contact our repair service (telephone number 175). Repair and travel to make repairs are free.

### Purchased device

Within the guarantee period, repairs are carried out without charge in accordance with the conditions of the guarantee. Excepted is damage due to parts subject to wearing (cables, labels, batteries, etc.) and damage due to improper use (damage due to dropping, water damage, batteries, etc.). If a repair is necessary, the device must be brought to the point of sale.

If the repair service is required (also during the guarantee period), a flat-rate travel fee and the time needed will be charged. Beyond the guarantee period the cost of materials will be added.

## Batteries

Batteries constitute consumable materials that are not included in the guarantee. Defective batteries are not replaced free of charge. This applies to leased and purchased devices.

## Help

If you have general questions about matters such as products and services, please contact Swisscom's call center (free number 0800 800 800).

## Cleaning – when it is necessary

Simply wipe the telephone with a slightly damp cloth or with an anti-static pad. Never use a dry cloth. Please avoid using cleaning agents and abrasives.

## Approval

This equipment is intended for operation on the Swiss ISDN network.

Country specific characteristics are taken into account. For inquiries concerning differences between public telephone networks, please contact your local dealer or network provider. This device complies with the fundamental requirements for terminal guidelines and is confirmed by the CE mark.



This DECT cordless telephone complies with the fundamental requirements of R&TTE Directive 99/5/EC and is suitable for connection and operation in the member country specified on the base station and/or packaging.



# Technical Data

## DECT

Standard: DECT/GAP  
Frequency range: 1880 MHz to 1900 MHz  
Transmit output: 10 mW, mean output per channel  
Range: up to 250 m outdoors  
up to 40 m inside buildings  
Dialling mode: Dual Tone MultiFrequency dialling

## Power supply

Power supply: SNG 6 af  
primary: 220/230 V~/50 Hz  
secondary: 7,5 V/500 mA

Rechargeable batteries: 3 x 1.2 V  
NiMH battery type AAA  
or NiCd battery type AAA

## Battery endurance

With NiMH: standby approx. 150 hrs  
talk time approx. 15 hrs  
with NiCd: standby approx. 70 hrs  
talk time approx. 7 hrs

## Permissible ambient conditions

for operation: 5 °C to 40 °C  
5% to 85% relative humidity

Permissible storage temperature:  
- 25 °C to + 70 °C

## Dimensions

Base station: approx. 135 x 125 x 125 mm  
Handset: approx. 145 x 51 x 30 mm

## Weight

Base station: approx. 200 g  
Handset: approx. 140 g



Warning:  
Circuit can be destroyed by electrostatic discharge!

## CE mark

The telephone complies with the requirements of the following European Directives:

EN 301 489-1/6 "Electromagnetic compatibility".

EN 60950 "Electrical equipment for use within specific voltage limits".



Compliance of the telephone with the aforementioned directives is confirmed by the CE mark.

# Menu structure in standby state

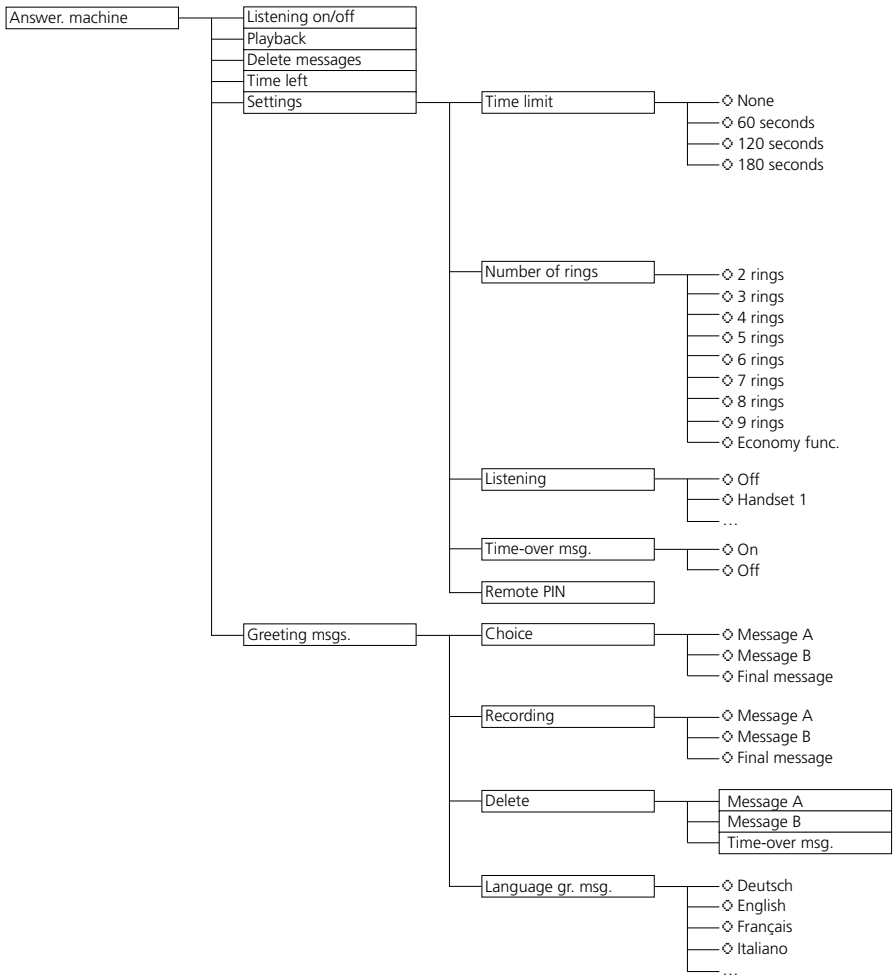

Keypad lock  
Ringer off/on

# Menu structure in standby state

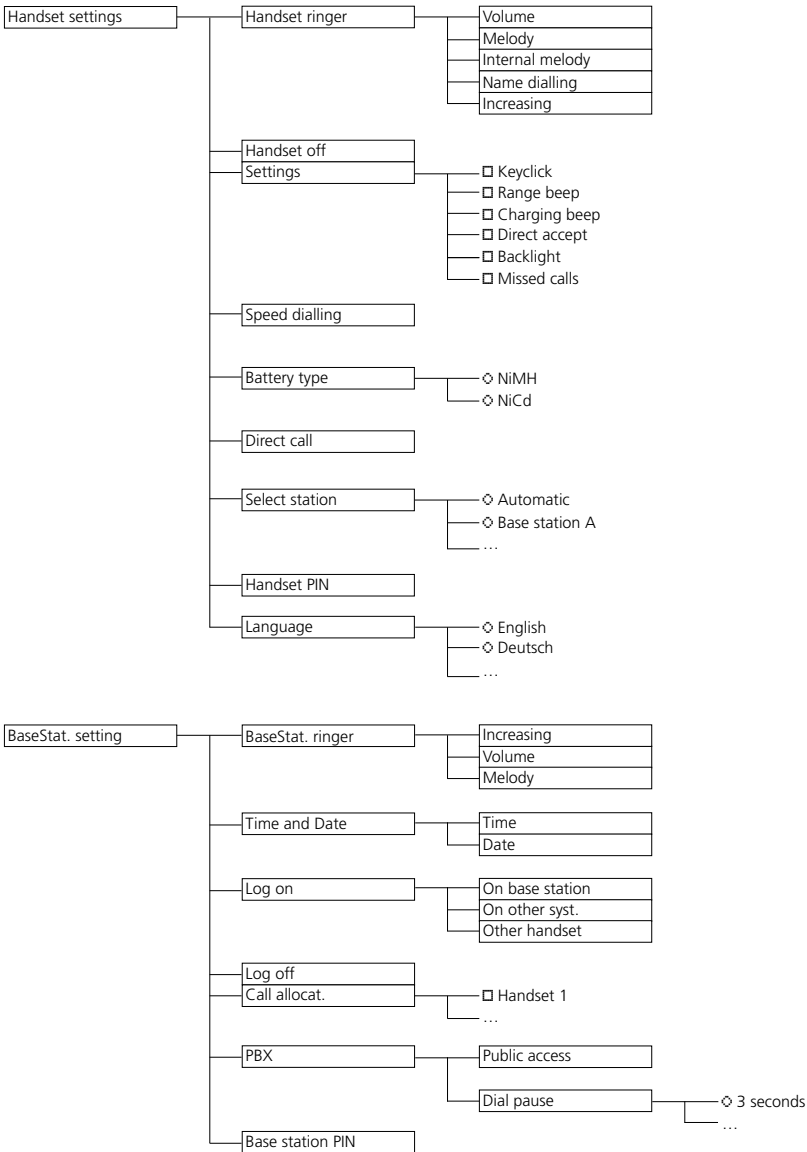

# Menu structure in standby state

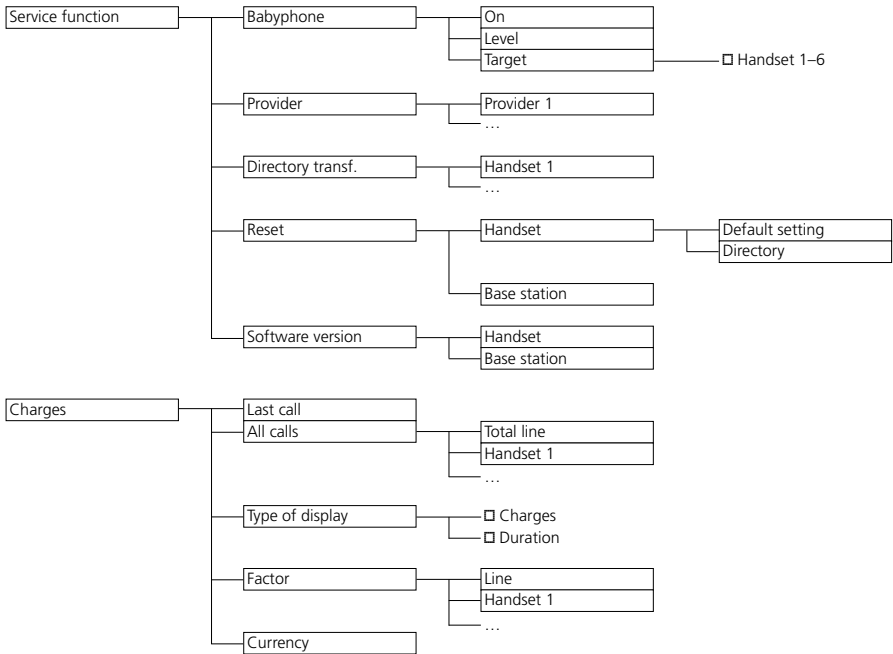

# Menu structure in standby state

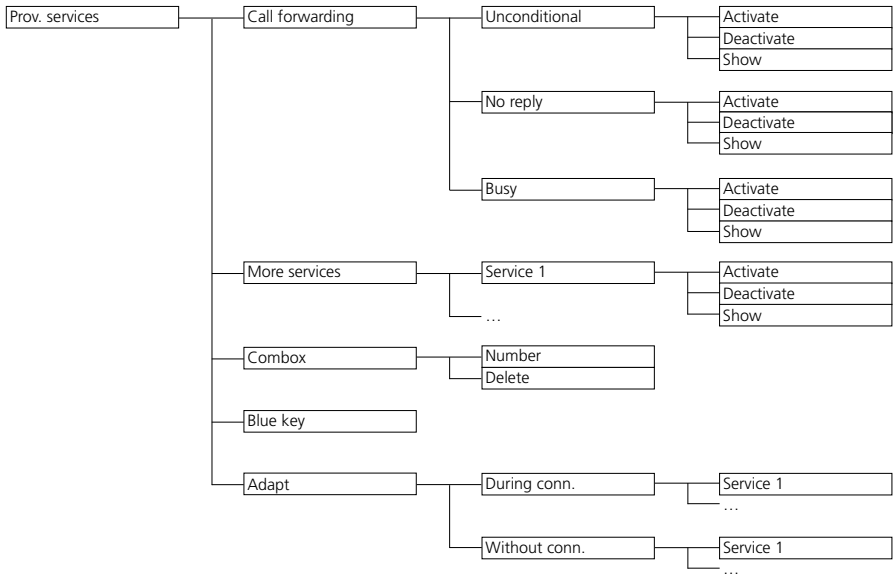

# Key words

## A

Accept a call .....	25
Acknowledgement sound .....	43
Anonymous calling (CLIR) .....	19
Answering machine on/off .....	62

## B

Babyphone .....	1, 49
Programming .....	49
Switching on .....	49
Backlight .....	43
Basic settings and operation .....	13
Batteries .....	12
Battery endurance .....	12, 69
Battery indicator .....	12
Beeps .....	43
Blue key .....	33
Brief description of services .....	31

## C

Cables, connect/disconnect .....	10
Call forwarding .....	28
Calls .....	2, 17, 24
Make an external call .....	17
Make an internal call .....	24
Calls, free, internal .....	24
Cancel key .....	A2, 14
Cause .....	67
CE mark .....	69
Charge status of batteries .....	12
Charges .....	34, 35
Charging batteries .....	12
Charging beep .....	43
Combox .....	33
Connect base station .....	10
Connect key .....	A2, 14
Contents of the package .....	8
Control key .....	A2, 14

## D

Date .....	46
Declaration of Conformity .....	77
DECT .....	A1, 69
Default setting, factory setting .....	53
Default state, resetting to .....	53
Dial externally .....	17
Dial from the directory .....	20
Dimensions .....	69
Direct accept .....	43
Direct call .....	40
Directory entry .....	20
Display .....	A2
Display icons .....	A2, 13
DTMF (temporary) .....	22

## E

Exchange identification code .....	19
------------------------------------	----

## F

Faults .....	67
--------------	----

## G

GAP .....	38
-----------	----

## H

Hands-free mode .....	2, 21
Handset	
Log off .....	38
Logging on .....	36
Switch on/off .....	42

## Key words

### I

Icon .....	13
Identification restriction (CLIR) .....	19
Inquiry .....	25
Inserting batteries .....	11
Internal key .....	14

### K

Keyclick .....	43
Keypad .....	A2, 22
Keypad lock .....	41

### L

Language .....	42
Listening .....	55
Location, suitable .....	9
Log off .....	38
Log on .....	1, 36, 37
Loudspeaker .....	55

### M

Main menu .....	13
Menu .....	13
Microphone .....	A2
Microphone mute .....	22
Monitoring outgoing message .....	59
Multifunction key .....	A2, 14
Mute switch .....	13, 22

### N

New cable layout .....	10
Numeric keys .....	14

### O

Off-line call preparation .....	20
Other handset, logging on .....	37

### P

PABX .....	19
Paging .....	24
Personal identification number ....	45, 47
Pick up .....	61
PIN .....	45, 47
Base station .....	47
Handset .....	45
Plug & Play .....	56
Power switched off .....	12
Protection against listening-in .....	9
Provider .....	19, 52
Provider services .....	28

### Q

Quick Reference User Guide .....	1
----------------------------------	---

### R

Range .....	9, 36, 43, 69
Receiver .....	A2
Record .....	22
Recording a call .....	56
Reject a call .....	25
Remaining within reach .....	28
Remedy .....	67
Remote access .....	63
Ringer	
Base station .....	46
Handset .....	44
Ringer off (do not disturb) .....	41
Ringer on/off .....	41

# Key words

## S

Select a base station .....	39
Setting	
Answering machine .....	54
Base station .....	46
Handset .....	42
Several base station .....	39
Several handsets .....	36
Shortcuts .....	14, 27
Software version .....	53
Speed dialling .....	2, 17
Standard message .....	56
Switching on in standby state .....	13
Symptom .....	67

## T

Technical Data .....	69
Temporary call screening .....	61
Three-party conference .....	26
Time .....	46
Time and date .....	46
Tones, clicks and beeps .....	43
Total recording time .....	54
Transfer .....	51
Transfer directory entries .....	51
Troubleshooting .....	67

## U

Unplugging/plugging in .....	10
------------------------------	----

## V

Volume .....	44
--------------	----

## W

Warning beep .....	9, 43, 58
Weight .....	69



# Declaration of Conformity

**swisscom** **fixnet**

## Declaration of Conformity

**Swisscom Fixnet AG, Customer Premises Equipments (CPE)**

**Alte Tiefenastrasse 6, CH-3050 Bern**

**declares that the Products**

**Swisscom Top A312**

**Swisscom Top A412**

(DECT Cordless Telephones, Fixed and Mobile Part for PSTN-Interface)

**corresponds to this declaration, with the following standards,  
technical requests and normative Documents**

Safety:	<b>EN 60 950</b>	(equivalent to 73/23/EC)
EMC	<b>EN 301 489-1/6</b>	(equivalent to 89/336/EC)
Radio	<b>EN 301 406</b>	(DECT)

The presumption of conformity with essential requirements regarding Council Directive 99/05/EC is ensured.

**Bern, 03.02.2003**

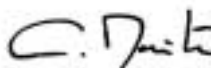

Christian Maitre  
Head of Productmanagement



Beat Schüpbach  
Product Manager





**swisscom**

**fixnet**